



FRASTEMA
ophthalmic equipments



art. 76TP
PATIENT CHAIR

Multifaceted functionality for clinic and practice

art. 76TP PATIENT CHAIR



technical data

Length (sitting position).....	1210 mm
Length (lying position).....	1824 mm
Total height (sitting position).....	1350 mm
Total height (lying position).....	775 mm
Width.....	700 mm
Height seat (sitting position).....	590 mm
Net weight.....	120 kg
Max. patient weight.....	300 kg

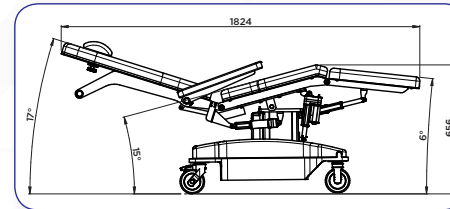
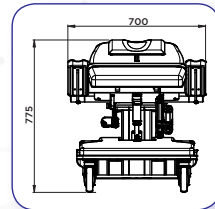
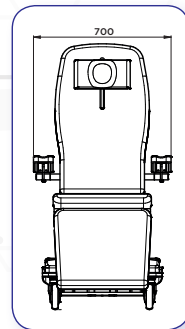
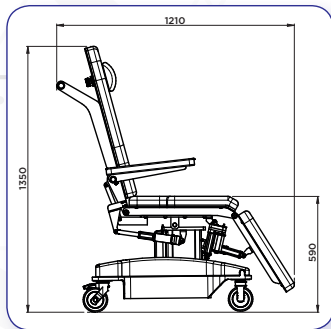









MULTIFACETED FUNCTIONALITY FOR CLINIC AND PRACTICE

Chair, stretcher, transporter and wake-up bed all in one. The 76TP patient chair has also established itself for laser treatments and cosmetic treatments. Its slim, high-quality construction and modern design make it an indispensable all-rounder in clinics and practices. Accessories and colour options allow it to be individually adapted to your requirements.

- Robust frame made of solid stainless steel
- Proper patient positioning in one product: chair position, reclining position, chaise longue position and Trendelenburg position
- Automatic adjustment of armrests to the lying position, can also be folded up if required
- Featuring two solid steering handles on the upper edge of the backrest for effortless, selective steering manoeuvres
- Comfortable padding in contemporary design and hygienic finish
- Physiologically favorable lying surface
- Shapely, particularly smooth-running, steering-braked wheels
- Adjustability via 2 mechanical turning handles at the head end
- If necessary, the patient can adjust the position on the side of the 76TP Patient Transporter chair himself

Chair colours

	29 SKINFLEX BLUE		29 SKINFLEX BLUE
	AT 62/64 COLORADO OCEANO		28 SKINFLEX GREEN
	AT 62/51 COLORADO BEIGE		06 SKINFLEX YELLOW
	31 SKINFLEX GREY		08 SKINFLEX RED